



Product Information  
Version 1.0

## **ZEISS Axiolab 5**

Your Smart Microscope for More Efficient Routine Lab Work



# Your Smart Microscope for More Efficient Routine Lab Work

- › **In Brief**
- › The Advantages
- › The Applications
- › The System
- › Technology and Details
- › Service

Axiolab 5 is made for the routine microscopy work that goes on every day in your lab. Its compact and ergonomic design saves space and makes for easy handling. Axiolab 5 is a real team player. Combine it with Axiocam 208 color and take full advantage of the smart microscopy concept: you'll be experiencing a completely new form of digital documentation. Just focus your sample and press a single button for crisp images in true color. The digital image will look like you see it through the eyepieces, with all the details and subtle color differences clearly visible. Plus, Axiolab 5 automatically adds the correct scaling information to your images. You get all of this in a standalone operation, without needing a PC or any additional software. Save time, money and valuable lab space with Axiolab 5. Digital documentation has never been easier.



# Simpler. More Intelligent. More Integrated.

- › In Brief
- › **The Advantages**
- › The Applications
- › The System
- › Technology and Details
- › Service

## Increase Efficiency in Your Routine Lab

Once you find a region of interest, simply press the snap button right on the stand to acquire the image. It's as easy as that. Axiolab 5 offers you an easy handling, ergonomic user concept that's adapted to your lab routine. You can control the microscope and its attached camera without even changing your grip. Your smart microscope system then automatically adjusts the parameters for you and documents your sample precisely as you see it through the eyepieces – detail-rich and in true color. The correct scaling is always included automatically. You don't need to invest in another computer or software either. With smart microscopy you'll work more efficiently and always stay focused on your sample.



## Clever Ergonomics for Relaxed Lab Work

Axiolab 5 is strong on ergonomomy and efficiency. You can access all the main controls with just one hand, including the Snap button, stage drive, focus adjustment, and brightness control. Ergotubes and the height and torque adaptable stage handle allow you to work in a comfortable position, even during extended use. The dual specimen holder means fewer slide changes – for example, when you're examining IHC slides – so fatigue is reduced. The new light manager provides uniform brightness at all magnifications, eliminating manual lamp intensity adjustments when changing objectives. Overall, Axiolab 5 minimizes and eases out manual steps, allowing you to work more efficiently and in greater comfort.

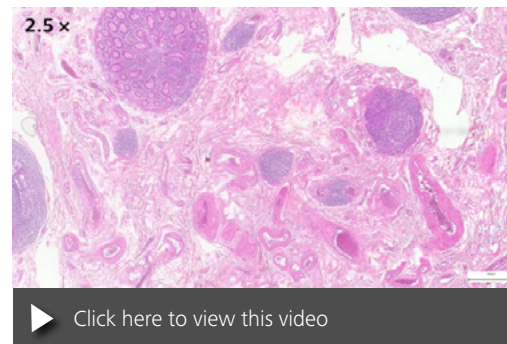

## More Economic and Reliable

Axiolab 5 is on your side when it comes to cost- and energy-saving. Activate Eco-mode, for instance, and Axiolab 5 automatically goes to standby after being idle for 15 minutes. This saves energy and extends illumination life time. LEDs have a long lifetime as compared to conventional illumination systems. In transmitted light, the new powerful white LED allows you to visualize your sample in natural colors. Even subtle color differences can be clearly seen. For fluorescence, the integrated LEDs in various wavelengths are easier and safer to use than e.g. classical mercury lamps. With LEDs, you avoid warm-up and cool-down times. Lamp replacement and lamp adjustment is a thing of the past. Save lab space and costs as Axiolab 5 with smart microscopy does not require an additional computer and software.



# Expand Your Possibilities

- › In Brief
- › **The Advantages**
- › The Applications
- › The System
- › Technology and Details
- › Service

## This is Smart Microscopy – Digital Documentation Made Easy

Used in combination with the microscope cameras Axiocam 202 mono or Axiocam 208 color, you have the full advantage of a smart stand-alone microscope solution.

Camera settings such as white balance, exposure time, and image enhancement functions are done automatically. Without needing additional imaging software or even a computer, you can:

- Snap images and record videos directly from your stand
- Use mouse (and optionally keyboard) to control your camera via OSD (on screen display)
- Save settings
- Store images with all metadata of the microscope and camera as well as scaling information
- Predefine the name or rename your image

### Stand-alone for Basic Routine Imaging



ZEISS Axiolab 5 operates independently of a computer system.

### ZEISS Labscope for Advanced Routine Imaging



Operating ZEISS Axiolab 5 with ZEISS Labscope imaging app is ideal for connected microscopy and standard multichannel fluorescence imaging.

### ZEISS ZEN for Research Applications



Use ZEN imaging software to perform advanced imaging tasks with ZEISS Axiolab 5.

# Expand Your Possibilities

- › In Brief
- › **The Advantages**
- › The Applications
- › The System
- › Technology and Details
- › Service

## Boost your Efficiency – with Smart Microscopy

Efficiency and quality are key in your lab, but it can take a lot of time to acquire detail-rich, true-color images. You know the drill: place the sample, focus your region of interest, switch to the computer, adjust settings such as white balance, exposure time and gain, then acquire an image, insert a scale bar, switch back to the microscope ... and so on. That's what a typical documentation workflow

looks like. Now, with the Axiolab 5 system, you can stay focused on your sample at all times, thanks to smart microscopy. Digital documentation is inherent in the system design. Just press the ergonomic Snap button on the microscope and you're done. The procedure integrates perfectly with your established microscopy workflow and boosts your efficiency tremendously.

### Routine imaging workflow



Smart functionality for digital documentation in brightfield and fluorescence for routine applications.

### Efficiency gain:

Eyes and hands stay on the microscope.



# Tailored Precisely to Your Applications

- › In Brief
- › The Advantages
- › **The Applications**
- › The System
- › Technology and Details
- › Service

Field of Application	Histopathology	Cytology	Hematology	Microbiology	Cytogenetics	Food & Agriculture	Andrology & Gynecology
<b>General Task</b>	Examination of sampled whole tissue sections for diseases	Evaluation of structure, composition and growth of single cells and cell structures	Examination of blood samples (EDTA blood) and bone marrow for quantity, shape, condition of blood cells	Study of pathogenic microorganisms that cause infectious disease	Study of chromosomal abnormalities in relation to cell behaviour/disease; molecular cytogenetic investigations	Examination of quality of food or beverage production; analyzing the nutritional content	Evaluation of sperm concentration, motility / vitality and sperm morphology; screen gynecological smears for cytological and microbiological findings
<b>Typical samples</b>	Histological tissue from e.g. organs such as lung or kidney	Pap smears; body fluids like urine, sputum, and pleural fluid; fine needle aspirations e.g. from lung	Blood smears, bone marrow smears	Bacteria, virus, fungi, parasites	Blood smears, bone marrow smears, cytopspins, tissue samples	Beer, wine, cheese, meat, crop, soy, starch	Gynecological smears, semen
<b>Common stainings/preparations</b>	Hematoxylin and eosin (H&E) staining, Immunohistochemistry; frozen sections, formalin fixed and paraffin embedded sections	Papanicolaou (PAP), Azur-Eosin-Methylenblue, Giemsa, Immunohistochemistry, FISH	Giemsa, Pappenheim	Gram stain, acidic-fast stain, methylene blue, Ziehl-Neelsen, immunofluorescence	Giemsa (G-banding), quinacrine and other banding stains, FISH	Native; gram staining; sections	Papanicolaou, Eosine-nigrosine, SPERMAC, immuno-fluorescence
<b>Typical contrasting techniques</b>	Brightfield	Brightfield, phase contrast	Brightfield, darkfield, DIC, fluorescence	Brightfield, darkfield, phase contrast, DIC, fluorescence	Brightfield, fluorescence	Brightfield, darkfield, phase contrast, polarization	Brightfield, phase contrast, fluorescence

# ZEISS Axiolab 5 at Work

- › In Brief
- › The Advantages
- › **The Applications**
- › The System
- › Technology and Details
- › Service

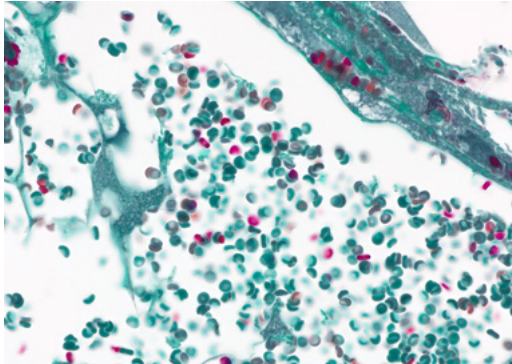

*Blood vessels, transmitted light brightfield, objective: Plan-Apochromat 40x/1.4*

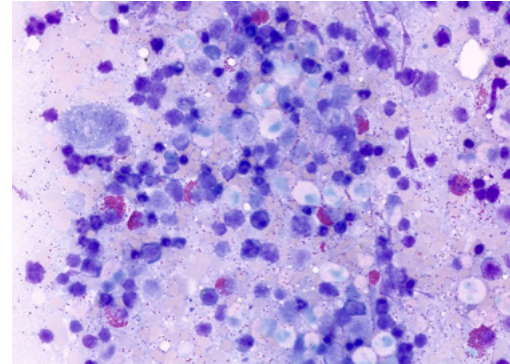

*Red bone marrow, transmitted light brightfield, objective: Plan-Apochromat 40x/1.4*

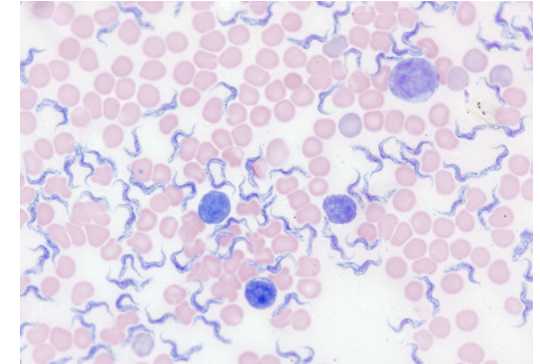

*Blood smear, Giemsa staining, transmitted light brightfield, objective: Plan-Apochromat 63x/1.4*

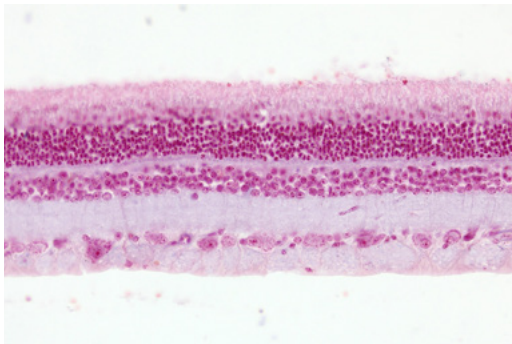

*Rat retina, section, nuclear fast red, transmitted light brightfield, objective: Plan-Apochromat 20x/0.8*

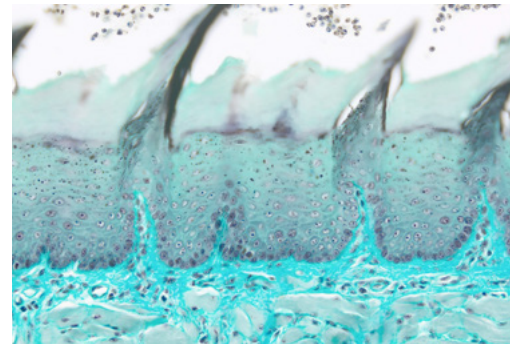

*Rat tongue, acid green, transmitted light brightfield, objective: Plan-Apochromat 20x/0.8*



*Varroa mite, transmitted light brightfield, objective: Plan-Apochromat 5x/0.16*

## Expand Your Possibilities

- › In Brief
- › The Advantages
- › **The Applications**
- › The System
- › Technology and Details
- › Service

Fluorescence microscopy requires an intense light source that will excite fluorescent dyes and proteins. Axiolab 5 FL is equipped with long lifetime, service- and adjustment-free and energy saving LED illumination, which allows for up to 3-channel fluorescence documentation. Each LED intensity can be controlled individually. Thanks to its encoding, Axiolab 5 recognizes which LED is currently in use and adjusts the light intensity to the last setting used.

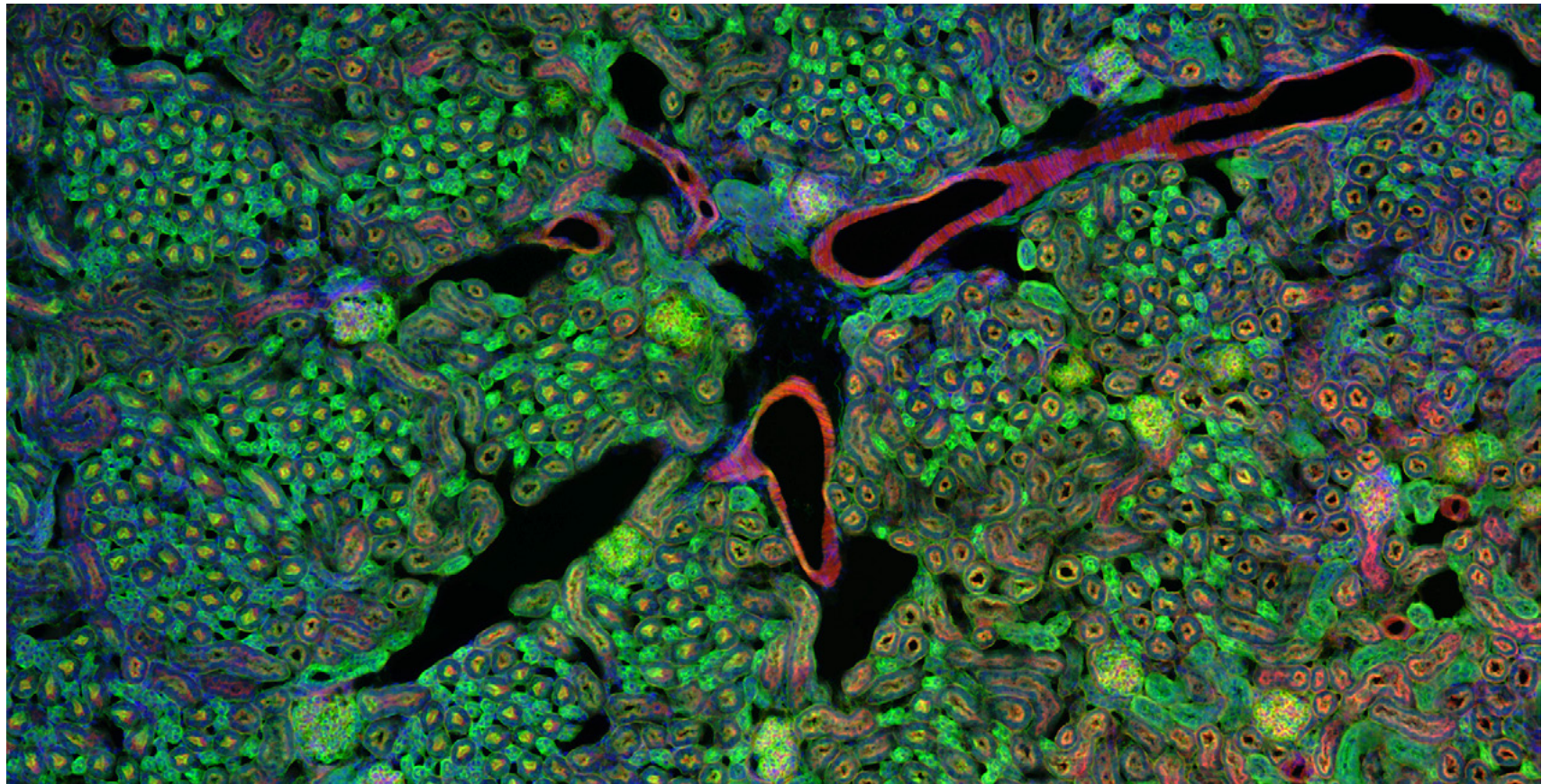

▶ [Click here to view this video](#)



# Expand Your Possibilities

- › In Brief
- › The Advantages
- › **The Applications**
- › The System
- › Technology and Details
- › Service

## Multidiscussion System

### Get A Great View from Every Position

You can use the multidiscussion system for training and consulting situations and in the medical field, for example when teaching students and doctoral candidates, when performing consultations, or when jointly evaluating difficult specimens. With the ZEISS multidiscussion system you achieve identical image orientations for all co-observers. Regardless of the configuration and number of observers, each co-observer sees the same image in the same orientation as the main observer. You can set up virtually any configuration – tailored precisely to the required number of co-observers and the available space. Should additional workstations be required, the system can easily be expanded at any time.

Each tube has its own support, optimally positioned at its center of gravity. This makes the system incredibly stable. The height of each support can be adjusted separately and, thanks to the ball-and-socket joint, any slight unevenness of the table or floor is automatically compensated for.

The movable light marker allows you to mark interesting structures or notable histological alterations in the prepared specimen. You provide an optimum orientation guide for differently stained specimens by continuously regulating the intensity of the light marker and selecting between the various color settings (white, green, red).

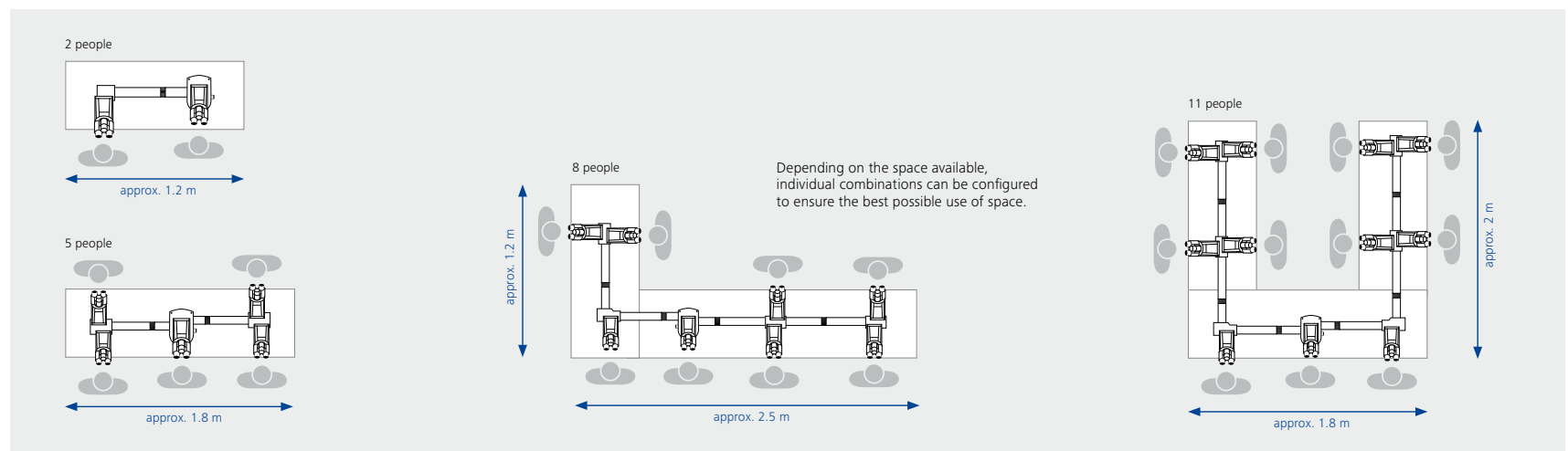

# Your Flexible Choice of Components

- › In Brief
- › The Advantages
- › The Applications
- › **The System**
- › Technology and Details
- › Service

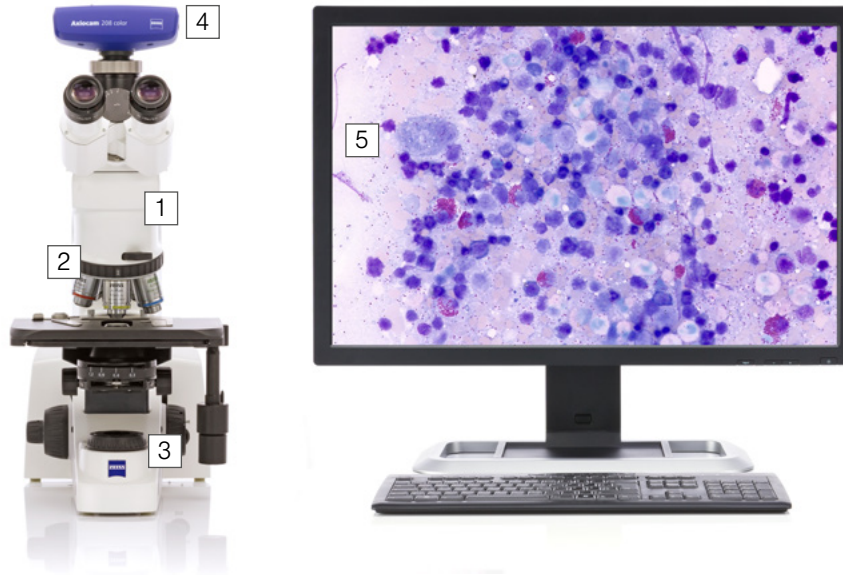

## 1 Microscope

ZEISS Axiolab 5:

- Encoded stand with transmitted light
- Encoded stand with transmitted light and reflected light fluorescence

## 2 Objectives

Recommended classes of objectives:

- A-Plan
- N-Achroplan
- EC Plan-NEOFLUAR

## 3 Illumination

Transmitted light:

- 10 W LED illumination
- 35 W halogen illumination (optional)

Reflected light:

- Up to 3 fluorescence LEDs

## 4 Cameras

Recommended cameras:

- ZEISS Axiocam 208 color  
(with Axiolab 5 encoded transmitted light stand)
- ZEISS Axiocam 202 mono  
(with Axiolab 5 encoded fluorescence stand)

## 5 Software

- Stand-alone (on screen display)
- Labscope imaging app
- ZEN imaging software

# System Overview

- › In Brief
- › The Advantages
- › The Applications
- › The System
- › Technology and Details
- › Service

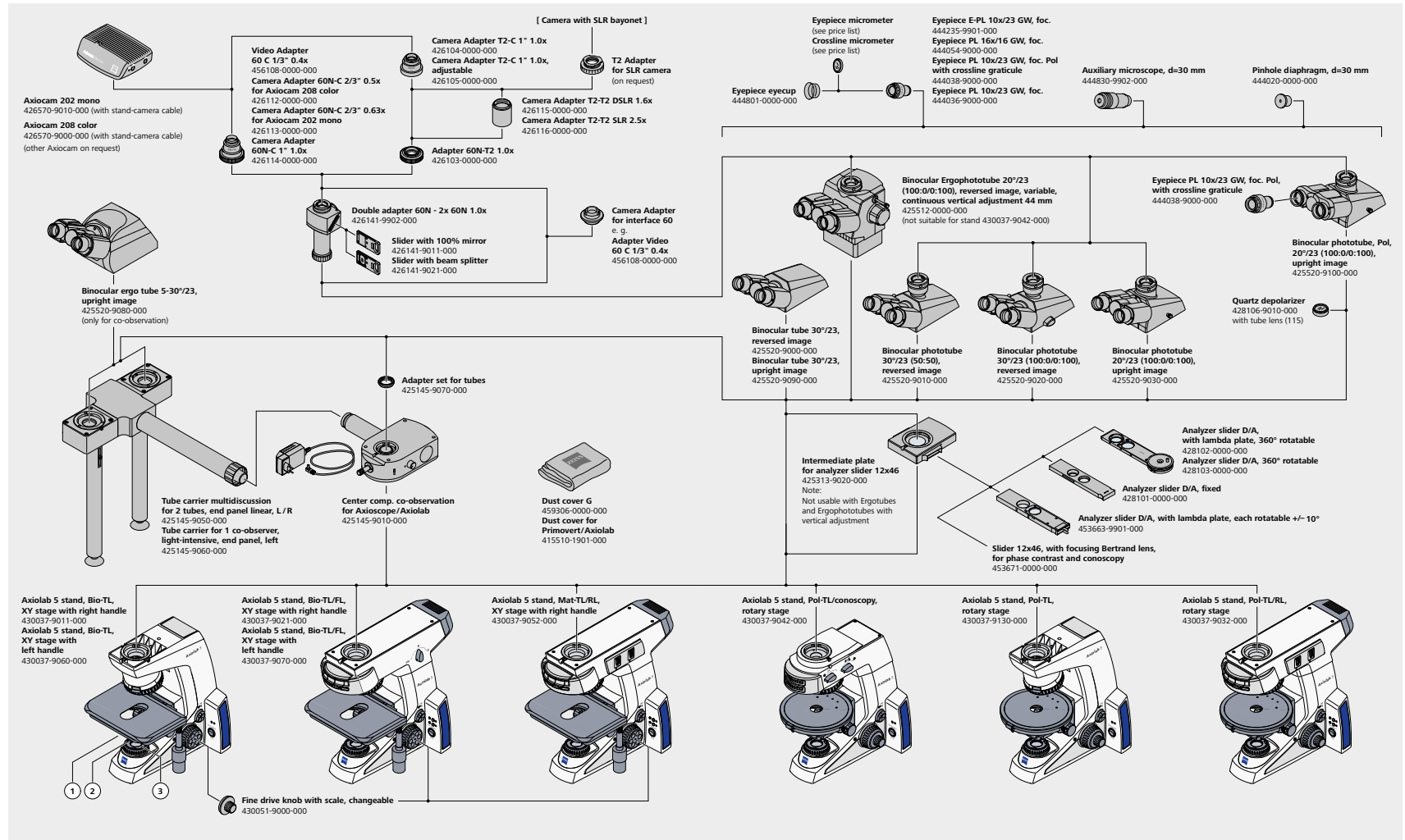

# System Overview

- › In Brief
- › The Advantages
- › The Applications
- › **The System**
- › Technology and Details
- › Service

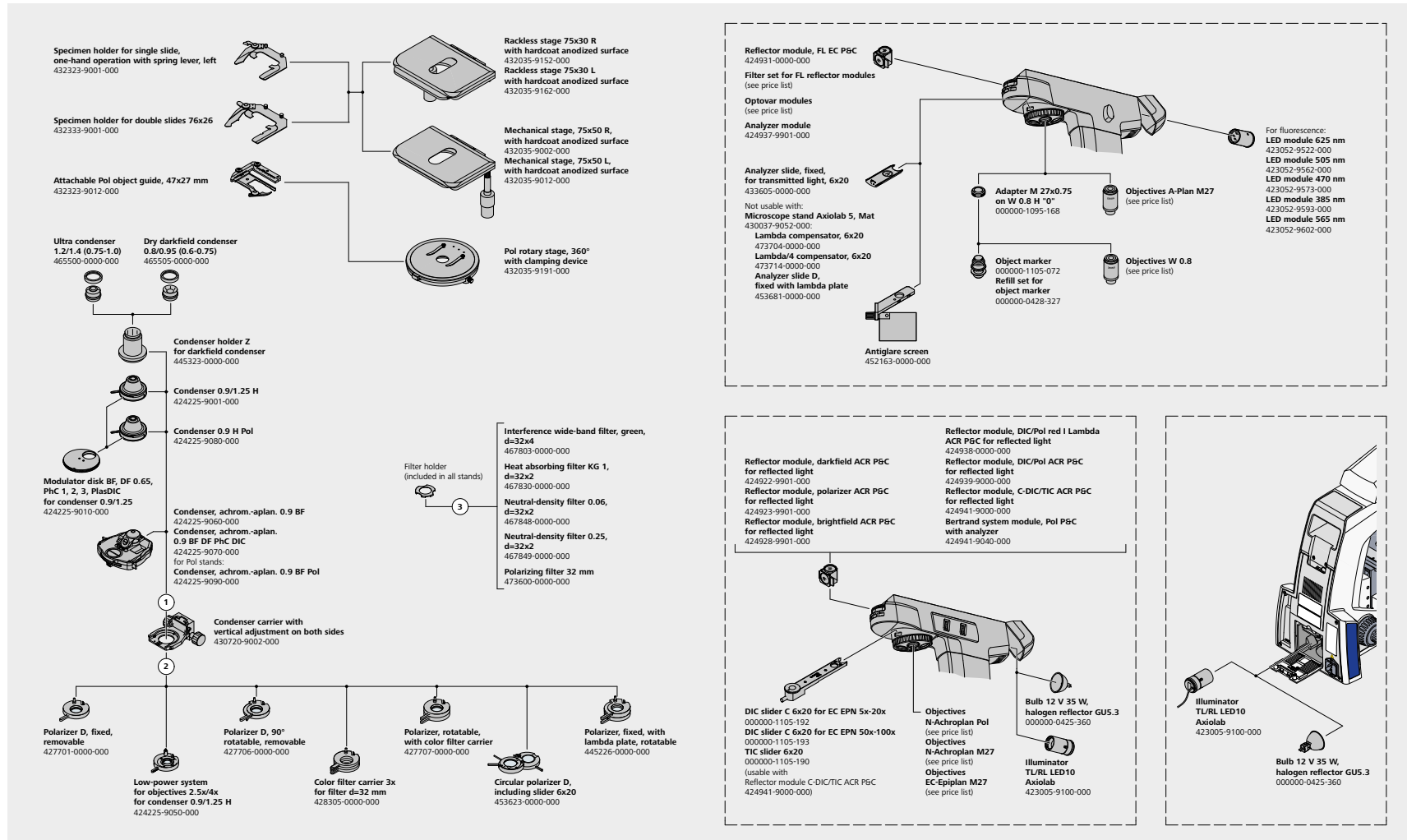

# Technical Specifications

- › In Brief
- › The Advantages
- › The Applications
- › The System
- › **Technology and Details**
- › Service

ZEISS Axiolab 5

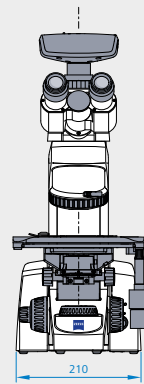
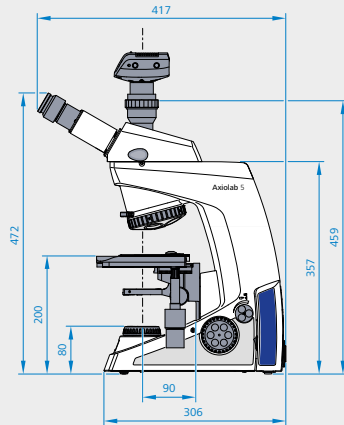

ZEISS Axiolab 5 FL

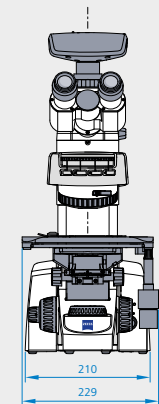
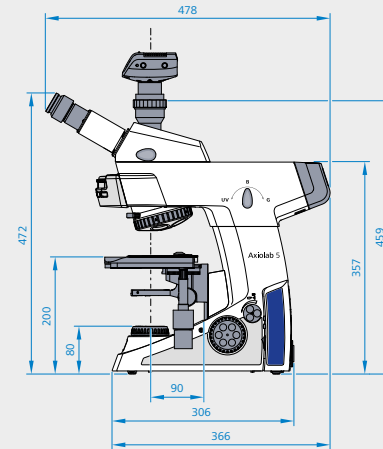

## Dimensions (length x width x height)

Axiolab 5 basic microscope stand without tube (430037-9011-000)

Approx. 304 mm x 210 mm x 357.5 mm

The other stand types differ slightly in depth and significantly in height, depending on the tube used.

## Operation

Permissible ambient temperature	+10 °C to +40 °C
Permissible relative humidity (without condensation)	Max. 75 % at 35 °C
Highest permitted altitude of use	2,000 m
Air pressure	800 hPa to 1,060 hPa
Degree of pollution	2

# Technical Specifications

- › In Brief
- › The Advantages
- › The Applications
- › The System
- › **Technology and Details**
- › Service

	ZEISS Axiolab 5 Stands	ZEISS Axiolab 5 TL	ZEISS Axiolab 5 TL+FL
<b>Transmitted light illumination</b>	Material Number	430037-9011-000	430037-9021-000
	TL light source	LED 10W Optional Hal 35W	LED 10W Optional Hal 35W
	TL filter holder	●	●
<b>Fluorescence/reflected light illumination</b>	FL/RL light source	NA	FL LED modules
	Independent intensity control on stand of each FL-LED	NA	●
	FL-LED intensity memory function	NA	●
	Automatic mechanical shutter in TL for fluorescence imaging	NA	●
	Reflector turret	NA	4-position, encoded
	RL/TL switch buttons	NA	●
<b>Observation and documentation</b>	Eco Mode	●	●
	Light Intensity Manager	●	●
	Snap button (to take images and videos) on stand	●	●
	Contrasting methods	BF, DF, Ph and simple TL Pol	BF, DF, Ph, FL and simple TL Pol
	Field of view	23 mm	23 mm
	Optical system	Infinite, IC <sup>2</sup> S	Infinite, IC <sup>2</sup> S
	Camera tube	●	●
	Full Köhler	●	●
<b>Stand</b>	Nosepiece	5X H, encoded, M27	5X H, encoded, M27
	Stage	Mechanical stage 75×50 (rackless with hardcoat anodized surface, right or left drive, extendable and with torque adjustment)	Mechanical stage 75×50 (rackless with hardcoat anodized surface, right or left drive, extendable and with torque adjustment)
	Z Focus range	15 mm	15 mm
	Focus Knob	Fine drive knob left and fine drive disk right	Fine drive knob left and fine drive disk right
	Specimen Holder	Dual slide holder for one-hand operation, spring lever left Optional: holder for single slide	Dual slide holder for one-hand operation, spring lever left Optional: holder for single slide
	Ergotube	●	●
	Eye-piece, diopter adjustment	Up to ± 5 diopter	Up to ± 5 diopter
	Integrated carrying handle	●	●
	Integrated solution to accommodate cable when stored	●	●
	Integrated solution to accommodate tools (allen wrench) when stored	●	●
	Power Unit	Integrated	Integrated

## Count on Service in the True Sense of the Word

- › In Brief
- › The Advantages
- › The Applications
- › The System
- › Technology and Details
- › **Service**

Because the ZEISS microscope system is one of your most important tools, we make sure it is always ready to perform. What's more, we'll see to it that you are employing all the options that get the best from your microscope. You can choose from a range of service products, each delivered by highly qualified ZEISS specialists who will support you long beyond the purchase of your system. Our aim is to enable you to experience those special moments that inspire your work.

### **Repair. Maintain. Optimize.**

Attain maximum uptime with your microscope. A ZEISS Protect Service Agreement lets you budget for operating costs, all the while reducing costly downtime and achieving the best results through the improved performance of your system. Choose from service agreements designed to give you a range of options and control levels. We'll work with you to select the service program that addresses your system needs and usage requirements, in line with your organization's standard practices.

Our service on-demand also brings you distinct advantages. ZEISS service staff will analyze issues at hand and resolve them – whether using remote maintenance software or working on site.

### **Enhance Your Microscope System.**

Your ZEISS microscope system is designed for a variety of updates: open interfaces allow you to maintain a high technological level at all times. As a result you'll work more efficiently now, while extending the productive lifetime of your microscope as new update possibilities come on stream.



*Profit from the optimized performance of your microscope system with a Carl Zeiss service contract – now and for years to come.*

>> [www.zeiss.com/microservice](http://www.zeiss.com/microservice)



**Carl Zeiss Microscopy GmbH**

07745 Jena, Germany  
microscopy@zeiss.com  
www.zeiss.de/axiolab



Not all products are available in every country. Use of products for medical diagnostic, therapeutic or treatment purposes may be limited by local regulations. Contact your local ZEISS representative for more information.  
EN\_41\_011\_204 | CZ 06-2019 | Design, scope of delivery, and technical progress subject to change without notice. | © Carl Zeiss Microscopy GmbH